



GUBERNUR DAERAH ISTIMEWA YOGYAKARTA

KEPUTUSAN GUBERNUR DAERAH ISTIMEWA YOGYAKARTA

NOMOR 412/KEP/2024

TENTANG

PERSETUJUAN PINJAM PAKAI BARANG MILIK DAERAH KEPADA PEMERINTAH
KOTA YOGYAKARTA BERUPA KOMPONEN PEMBANGUNAN PEDESTERIAN
KAWASAN SUMBU FILOSOFI

GUBERNUR DAERAH ISTIMEWA YOGYAKARTA,

- Menimbang :
- a. bahwa Walikota Yogyakarta melalui surat Nomor: 000.2.3.2/664 tanggal 16 Februari 2024, mengajukan permohonan pinjam pakai komponen pembangunan pedestrian Kawasan Sumbu Filosofi;
 - b. bahwa berdasarkan Surat dari Sekretaris Daerah Daerah Istimewa Yogyakarta Nomor 00.10.7/6840 tanggal 19 September 2024 perihal Laporan Hasil Penelitian Pinjam Pakai Barang Milik Daerah di Kawasan Sumbu Filosofi, Barang Milik Daerah tersebut belum digunakan atau tidak ada penggunaan Barang Milik Daerah oleh Pemerintah Daerah Daerah Istimewa Yogyakarta sehingga dapat dipinjam pakai untuk penyelenggaraan tugas dan fungsi peminjam;
 - c. bahwa berdasarkan ketentuan dalam Pasal 153 Peraturan Menteri Dalam Negeri Nomor 19 Tahun 2016 tentang Pedoman Pengelolaan Barang Milik Daerah sebagaimana telah diubah dengan Peraturan Menteri Dalam Negeri Nomor 7 Tahun 2024 tentang Perubahan Atas Peraturan Menteri Dalam Negeri Nomor 19 Tahun 2016 tentang Pedoman Pengelolaan Barang Milik Daerah, pelaksanaan pinjam pakai oleh pengelola barang/pengguna barang dilaksanakan setelah mendapatkan persetujuan Gubernur;

- d. bahwa berdasarkan pertimbangan sebagaimana dimaksud dalam huruf a, huruf b, dan huruf c, perlu menetapkan Keputusan Gubernur tentang Persetujuan Pinjam Pakai Barang Milik Daerah kepada Pemerintah Kota Yogyakarta berupa Komponen Pembangunan Pedesterian Kawasan Sumbu Filosofi;

- Mengingat :
1. Undang-Undang Nomor 3 Tahun 1950 tentang Pembentukan Daerah Istimewa Jogjakarta (Berita Negara Republik Indonesia Tahun 1950 Nomor 3), sebagaimana telah diubah terakhir dengan Undang-Undang Nomor 9 Tahun 1955 tentang Perubahan Undang-Undang Nomor 3 Jo. Nomor 19 Tahun 1950 tentang Pembentukan Daerah Istimewa Jogjakarta (Lembaran Negara Republik Indonesia Tahun 1955 Nomor 43, Tambahan Lembaran Negara Republik Indonesia Nomor 827);
 2. Undang-Undang Nomor 13 Tahun 2012 tentang Keistimewaan Daerah Istimewa Yogyakarta (Lembaran Negara Republik Indonesia Tahun 2012 Nomor 170, Tambahan Lembaran Negara Republik Indonesia Nomor 5339);
 3. Undang-Undang Nomor 23 Tahun 2014 tentang Pemerintahan Daerah (Lembaran Negara Republik Indonesia Tahun 2014 Nomor 244, Tambahan Lembaran Negara Republik Indonesia Nomor 5587), sebagaimana telah diubah beberapa kali terakhir dengan Undang-Undang Nomor 6 Tahun 2023 tentang Penetapan Peraturan Pemerintah Pengganti Undang-Undang Nomor 2 Tahun 2022 tentang Cipta Kerja Menjadi Undang-Undang (Lembaran Negara Republik Indonesia Tahun 2023 Nomor 41, Tambahan Lembaran Negara Republik Indonesia Nomor 6856);
 4. Peraturan Pemerintah Nomor 31 Tahun 1950 tentang Berlakunya Undang-Undang Nomor 2 Tahun 1950 tentang Pembentukan Propinsi Djawa Timoer, Undang-Undang Nomor 3 Tahun 1950 tentang Pembentukan Daerah Istimewa Jogjakarta, Undang-Undang Nomor 10 Tahun 1950 tentang Pembentukan Propinsi Djawa Tengah, dan Undang-Undang Nomor 11 Tahun 1950 tentang Pembentukan Propinsi Djawa

Barat (Berita Negara Republik Indonesia Tahun 1950 Nomor 58);

5. Peraturan Menteri Dalam Negeri Nomor 19 Tahun 2016 tentang Pedoman Pengelolaan Barang Milik Daerah (Berita Negara Republik Indonesia Tahun 2016 Nomor 547) sebagaimana telah diubah dengan Peraturan Menteri Dalam Negeri Nomor 7 Tahun 2024 tentang Perubahan Atas Peraturan Menteri Dalam Negeri Nomor 19 Tahun 2016 Tentang Pedoman Pengelolaan Barang Milik Daerah (Berita Negara Republik Indonesia Tahun 2024 Nomor 350);
6. Peraturan Daerah Daerah Istimewa Yogyakarta Nomor 6 Tahun 2018 tentang Pengelolaan Barang Milik Daerah (Lembaran Daerah Provinsi Daerah Istimewa Yogyakarta Tahun 2018 Nomor 6, Tambahan Lembaran Daerah Provinsi Daerah Istimewa Yogyakarta Nomor 6);

MEMUTUSKAN :

Menetapkan : KEPUTUSAN GUBERNUR TENTANG PERSETUJUAN PINJAM PAKAI BARANG MILIK DAERAH KEPADA PEMERINTAH KOTA YOGYAKARTA BERUPA KOMPONEN PEMBANGUNAN PEDESTERIAN KAWASAN SUMBU FILOSOFI.

KESATU : Menyetujui Pinjam Pakai Barang Milik Daerah kepada Pemerintah Kota Yogyakarta berupa komponen pembangunan pedestrian Kawasan Sumbu Filosofi sebagaimana tercantum dalam Lampiran yang merupakan bagian tidak terpisahkan dari keputusan ini.

KEDUA : Barang Milik Daerah sebagaimana dimaksud dalam Diktum KESATU, dimanfaatkan untuk penataan pedestrian di Kawasan Sumbu Filosofi.

KETIGA : Jangka waktu pinjam pakai adalah 5 (lima) tahun, terhitung sejak tanggal tanggal 1 Oktober 2024 sampai dengan 30 September 2029.

KEEMPAT : Pelaksanaan pinjam pakai akan diatur lebih lanjut dengan Perjanjian yang ditandatangani oleh Sekretaris Daerah Daerah Istimewa Yogyakarta dengan Sekretaris Daerah Kota Yogyakarta sekaligus merupakan Berita Acara Serah Terima Barang.

KELIMA : Keputusan ini mulai berlaku pada tanggal ditetapkan.

Ditetapkan di Yogyakarta
pada tanggal 24 OKTOBER 2024

GUBERNUR
DAERAH ISTIMEWA YOGYAKARTA,

HAMENGGU BUWONO X



Salinan Keputusan ini disampaikan kepada Yth:



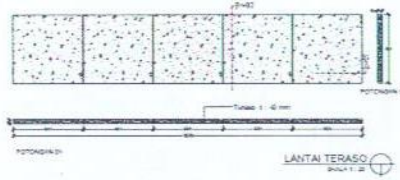

1. Walikota Yogyakarta;
 2. Sekretaris Daerah DIY;
 3. Kepala Dinas Pekerjaan Umum Perumahan dan ESDM DIY;
 4. Kepala Badan Pengelola Keuangan dan Aset DIY;
- untuk diketahui dan/atau dipergunakan sebagaimana mestinya.

LAMPIRAN
 KEPUTUSAN GUBERNUR
 DAERAH ISTIMEWA YOGYAKARTA
 NOMOR 412 / KEP / 2024
 TENTANG
 PERSETUJUAN PINJAM PAKAI BARANG MILIK DAERAH
 KEPADA PEMERINTAH KOTA YOGYAKARTA BERUPA
 KOMPONEN PEMBANGUNAN PEDESTRIAN
 KAWASAN SUMBU FILOSOFI



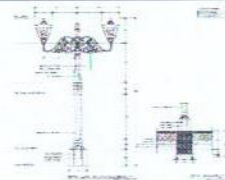
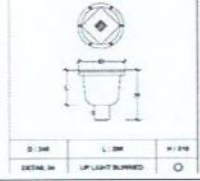

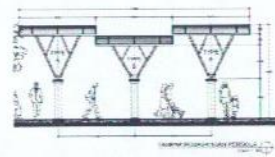
DAFTAR BARANG MILIK DAERAH

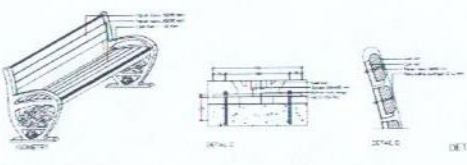
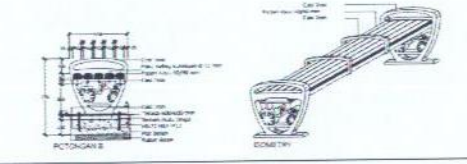
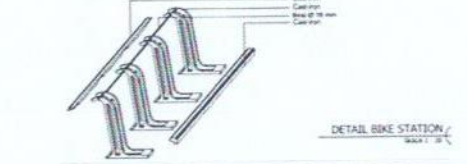
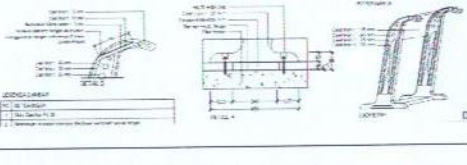
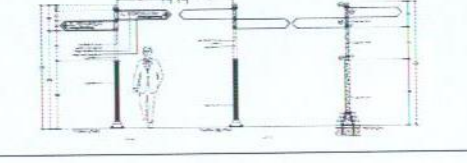

1. Lokasi Pedestrian Malioboro dan Margomulyo

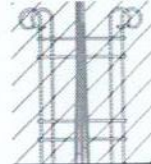
No	Nama Barang	Volume	Satuan	Gambar	Keterangan		
					Kondisi		Pengadaan
					Baik	Rusak	
1	Teraso	8,437.92	m ²		8,437.92		TA 2016
2	Teraso Huruf Jawa	9	unit		9.00		TA 2016

3	Lampu Lalu Lintas/ Lampu Pedestrian Malioboro/ Lampu Budaya	50	unit		50.00		TA 2016
4	Lampu Flood Light 150 W	166	unit		166.00		TA 2016
5	Guiding Block (batang)	14,025.00	unit	 Tactile Type 01 Tebal 40 mm	13,731.00	294.00	TA 2016
6	Guiding Block (bulat)	7,056.00	unit	 Tactile Type 02 Tebal 40 mm	6,927.00	129.00	TA 2016
7	Pergola	27	unit		27.00		TA 2016
8	Boolard Bulat	73	unit	 Bollard 01 (Bulat) - Penempatan Bollard 01 Berada Di Pinggir Jalan Besar Setiap Jarak ± 1200 mm	73.00		TA 2016





9	Boollard Tabung	405	unit	 <p>Bollard 02 (GIP) - Penempatan Bollard 02 Jarak ± 600 mm</p>	399.00	6.00	TA 2016
10	Bench dengan Sandaran	115	unit		114.00	1.00	TA 2016
11	Bench tanpa Sandaran	54	unit		54.00		TA 2016
12	Bike Station	10	unit		6.00	4.00	TA 2016
13	Signage Hanacaraka	7	unit		7.00		TA 2016
14	Signage Jalan	4	unit		4.00		TA 2016

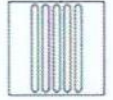

15	Tiang Bendera	20	unit		20.00		TA 2016
16	Trees Case	84	unit	 Trees Grate Dan Trees Case - Penempatan Trees Grate Dan Trees Case Berada Di Pohon Baru yang Berjarak ± 9000 mm	80.00	4.00	TA 2016
17	Trees Grate	84	unit	 Trees Grate Dan Trees Case - Penempatan Trees Grate Dan Trees Case Berada Di Pohon Baru yang Berjarak ± 9000 mm	80.00	4.00	TA 2016
18	Soka Kuning I	223.9	m2	 Soka merah dan orange	215.02	8.88	TA 2016
19	Soka Merah II	73	m2	 Soka merah dan orange	70.12	2.88	TA 2016
20	Soka Orange I	271.62	m2	 Soka merah dan orange	261.06	10.56	TA 2016

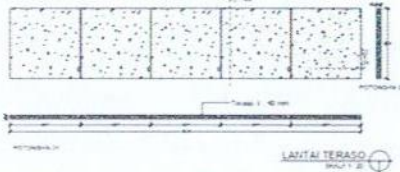

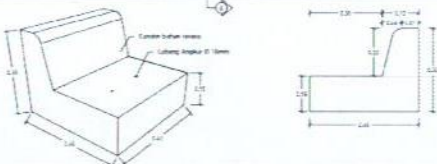

21	Pohon Asam	75	btg	 Pohon Asam Jawa	72.00	3.00	TA 2016
22	Pohon Gayam I	9	btg	 Pohon Gayam	9.00		TA 2016
23	Tempat Sampah	94	unit		94.00		TA 2016

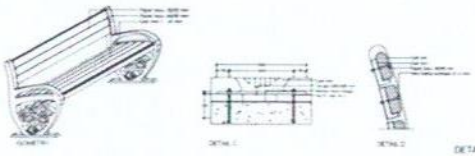

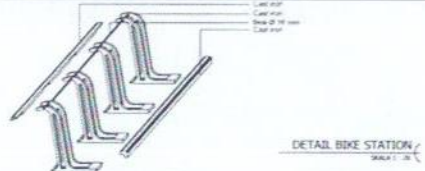
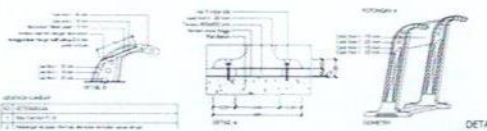
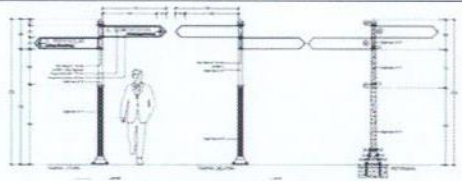
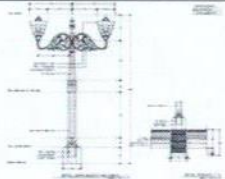
2. Lokasi Depan Pasar Beringharjo-Depan Vredeburg-Depan Gedung Agung

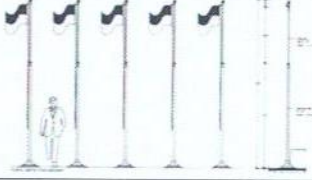
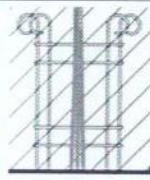
No	Nama Barang	Volume	Satuan	Gambar	Keterangan		
					Kondisi		Pengadaan
					Baik	Rusak	
1	Guiding Block (batang)	9,695.00	unit	 Tactile Type 01 Tebal 40 mm	9,493.00	202.00	TA 2027



2	Guiding Block (bulat)	4,091.00	unit	 Tactile Type 02 Tebal 40 mm	4,002.00	89.00	TA 2027
3	Teraso 120 X120	4,995.79	m2		4,995.79		TA 2027
4	Teraso Huruf Jawa	5.00	bh	 Lantai Hanacaraka	5.00		TA 2027
5	Kansteen teraso solid	340.00	m		340.00		TA 2027
6	Boolard Bulat	275.00	bh	 Bollard 01 (Bulat) - Penempatan Bollard 01 Berada Di Pinggir Jalan Besar Setiao Jarak ± 1200 mm	275.00		TA 2027
7	Boolard Tabung	35.00	bh	 Bollard 02 (GIP) - Penempatan Bollard 02 Jarak ± 600 mm	35.00		TA 2027

8	Bench dengan Sandaran	50.00	unit		50.00		TA 2027
9	Bench tanpa Sandaran	156.00	unit		154.00		TA 2027
10	Bike Station	13.00	unit		11.00		TA 2027
11	Signage Hanacaraka	3.00	unit		3.00		TA 2027
12	Signage Jalan	18.00	unit		18.00		TA 2027
13	Lampu Budaya	20.00	unit		17.00		TA 2027

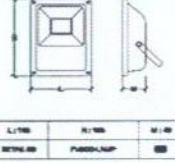
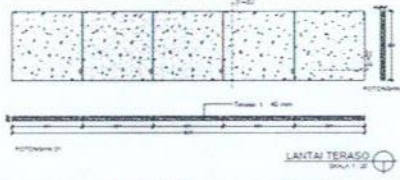
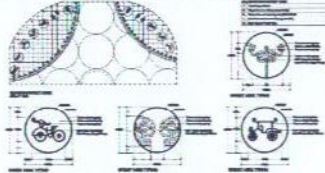
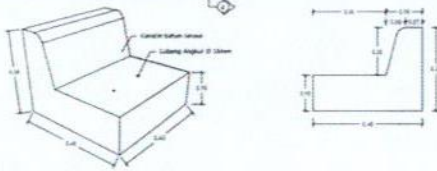
14	Tiang Bendera	15.00	unit		12.00		TA 2027
15	Trees Case	108.00	unit	 Trees Grate Dan Trees Case - Penempatan Trees Grate Dan Trees Case Berada Di Pohon Baru yang Berjarak ± 9000 mm	108.00		TA 2027
16	Trees Grate	108.00	unit	 Trees Grate Dan Trees Case - Penempatan Trees Grate Dan Trees Case Berada Di Pohon Baru yang Berjarak ± 9000 mm	108.00		TA 2027
17	Soka Merah	17.04	m2	 Soka merah dan orange	16.08	0.96	TA 2027
18	Soka Orange	27.36	m2	 Soka merah dan orange	26.64	0.72	TA 2027
19	Pohon Asam	97.00	btg	 Pohon Asam Jawa	97.00		TA 2027

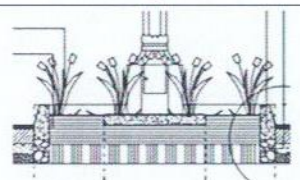
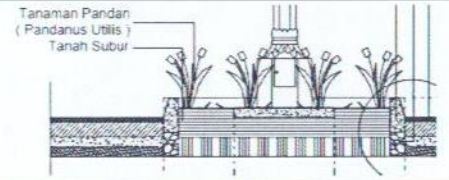
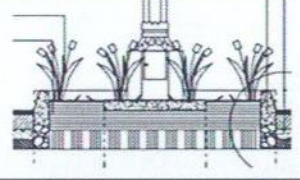
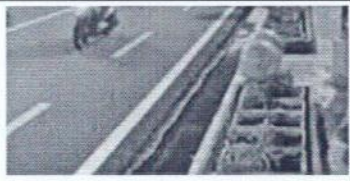
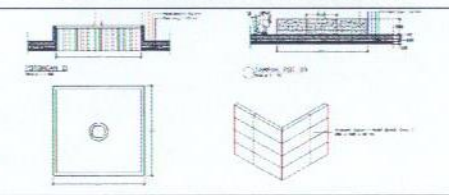
20	Pohon Gayam	11.00	btg		Pohon Gayam	11.00	TA 2027						
21	Tempat Sampah	36.00	unit			36.00	TA 2027						
22	Lampu Flood Light 150 W	76.00	Bh	 <table border="1" data-bbox="1383 738 1557 787"> <thead> <tr> <th>L/150</th> <th>H/150</th> <th>W/40</th> </tr> </thead> <tbody> <tr> <td>RETNL-03</td> <td>FL003L-150P</td> <td>03</td> </tr> </tbody> </table>	L/150	H/150	W/40	RETNL-03	FL003L-150P	03		76.00	TA 2027
L/150	H/150	W/40											
RETNL-03	FL003L-150P	03											
23	Lantai teraso pedestrian 600 x 600	686.19	m2			686.19	TA 2027						
24	Teraso Icon	11.00	unit			11.00	TA 2027						
25	Kansteen teraso solid Pendek	738.00	m			738.00	TA 2027						

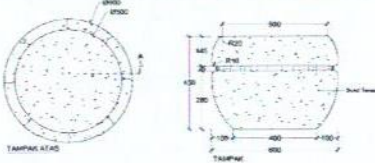
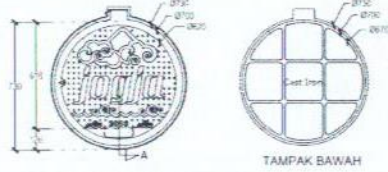
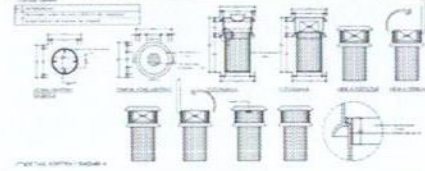

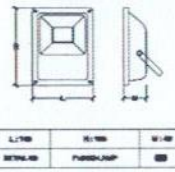

26	Portal C Pipa Stainless Steel	2.00	unit		2.00		TA 2027
27	Tanaman Bakung	65.75	m2		65.75		TA 2027
28	Tanaman Pandan	93.84	m2		89.04	4.80	TA 2027
29	Tanaman Rumput Gajah Mini	131.76	m2		131.76		TA 2027
30	Pot Tanaman Soka	576.00	bh		576.00		TA 2027
31	Batu Cover Pot Tanaman	162.07	m2		162.07		TA 2027

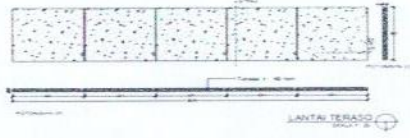
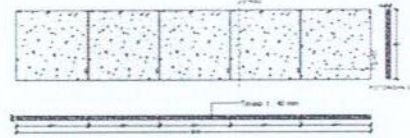
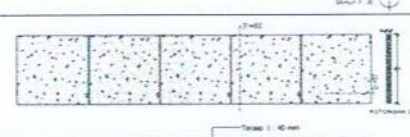
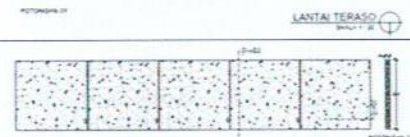
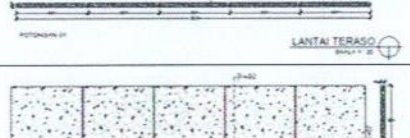

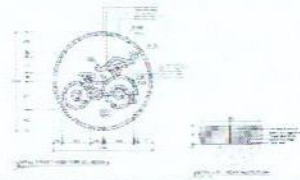
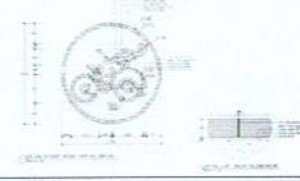
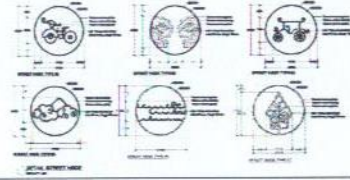
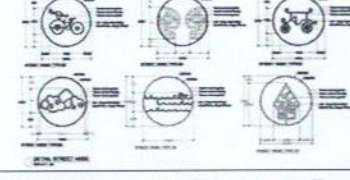
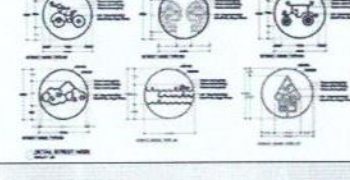
32	Bench 0 KM	144.00	bh		144.00	TA 2027						
33	Maintenance Hole	15.00	unit		15.00	TA 2027						
34	Tempat Sampah Dan Asbak	35.00	bh		35.00	TA 2027						
35	Drinking Fountain	2.00	unit		2.00	TA 2027						
36	Lampu Buried	22.00	bh	 <table border="1" data-bbox="1383 1112 1557 1153"> <thead> <tr> <th>L. 1/20</th> <th>K. 1/20</th> <th>W. 1/20</th> </tr> </thead> <tbody> <tr> <td>Ø170x140</td> <td>Ø170x140</td> <td>Ø170</td> </tr> </tbody> </table>	L. 1/20	K. 1/20	W. 1/20	Ø170x140	Ø170x140	Ø170	17.00	TA 2027
L. 1/20	K. 1/20	W. 1/20										
Ø170x140	Ø170x140	Ø170										

3. Lokasi Sisi Barat-Margo Mulyo dan Sisi Barat-Margo Utomo-Pangurakan

No	Nama Barang	Volume	Satuan	Gambar	Keterangan		
					Kondisi		Pengadaan
					Baik	Rusak	
1	Teraso 120x120 (Malioboro Sisi Barat)	8,681.05	m2		8,681.05		TA 2018
2	Teraso 120x120 (Margamulya Sisi Barat)	2,217.39	m2		2,217.39		TA 2018
3	Teraso 120x120 (Pangurakan Sisi Barat)	1,317.35	m2		1,317.35		TA 2018
4	Teraso 120x120 (Pangurakan Sisi Timur)	2,183.69	m2		2,183.69		TA 2018
5	Teraso 120x120 (Margautama)	559.82	m2		559.82		TA 2018
Total Teraso 102 x 120		14,959.30	m2		14,959.30		



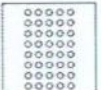

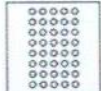
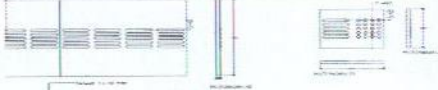
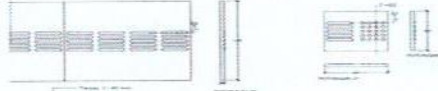
6	Teraso Icon D 210 icon alumunium (Malioboro Sisi Barat)	20.00	bh		20.00		TA 2018
7	Teraso Icon D 210 icon alumunium (Margamulya Sisi Barat)	4.00	bh		4.00		TA 2018
Total Teraso Icon		24.00	bh		24.00		
8	Teraso Art Work 240x240 (Malioboro Sisi Barat)	8.00	unit		7.00	1.00	TA 2018
9	Teraso Art Work 240x240 (Margamulya Sisi Barat)	4.00	unit		3.00	1.00	TA 2018
10	Teraso Art Work 240x240 (Pangurakan Sisi Barat)	2.00	unit		1.00	1.00	TA 2018
Total Teraso		14.00	unit		11.00	3.00	



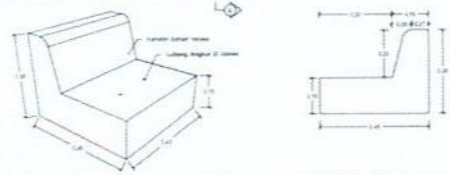
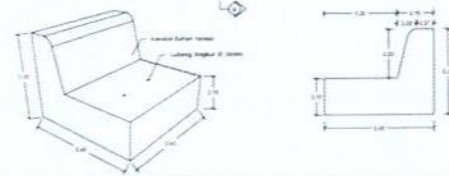
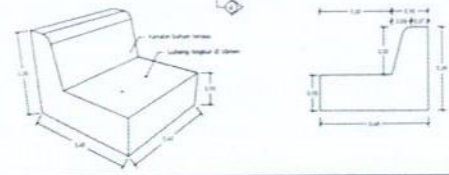
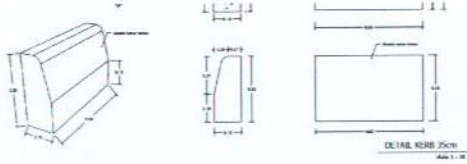
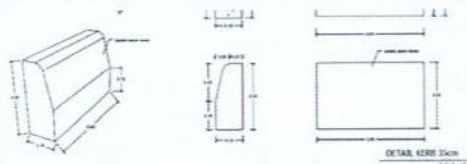
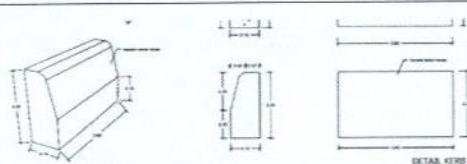

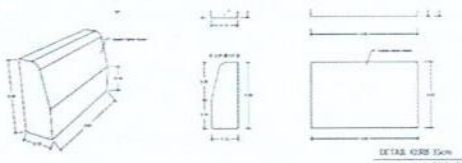
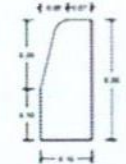
11	Teraso Lantai Huruf Jawa 240x240 (Pangurakan Sisi Timur)	2.00	unit	 Lantai Hanacaraka	2.00		TA 2018
Total Teraso Lantai Huruf Jawa		2.00			2.00		
12	Tactile bar (Malioboro Sisi Barat)	13,165.00	unit	 Tactile Type 01 Tebal 40 mm	12,879	286.00	TA 2018
13	Tactile bar (Margamulya Sisi Barat)	3,450.00	unit	 Tactile Type 01 Tebal 40 mm	3,375	75.00	TA 2018
14	Tactile bar (Pangurakan Sisi Barat)	3,585.00	unit	 Tactile Type 01 Tebal 40 mm	3,507	78.00	TA 2018
15	Tactile bar (Pangurakan Sisi Timur)	3,690.00	unit	 Tactile Type 01 Tebal 40 mm	3,610	80.00	TA 2018
Total Tactile Bar		23,890.00	unit		23.371	519	



16	Tactile dot (Malioboro Sisi Barat)	1,965.00	unit	 Tactile Type 02 Tebal 40 mm	1,850.00	115.00	TA 2018
17	Tactile dot (Margamulya Sisi Barat)	718.00	unit	 Tactile Type 02 Tebal 40 mm	676.00	42.00	TA 2018
18	Tactile dot (Pangurakan Sisi Barat)	772.00	unit	 Tactile Type 02 Tebal 40 mm	727.00	45.00	TA 2018
19	Tactile dot (Pangurakan Sisi Timur)	1,820.00	unit	 Tactile Type 02 Tebal 40 mm	1,714.00	106.00	TA 2018
Total Tactile Dot		5,275.00	unit		4.967.00	308.00	
20	Tactile Pembatas PKL (Malioboro Sisi Barat)	2,193.00	unit		2,066.00	127.00	TA 2018
21	Tactile Pembatas PKL (Margamulya Sisi Barat)	470.00	unit		443.00	27.00	TA 2018
Total Tactile Pembatas PKL		2,663.00	unit		2.509.00	154.00	



22	Kansteen teraso solid (Malioboro Sisi Barat)	1,530.00	unit		1,530.00		TA 2018
23	Kansteen teraso solid (Margamulya Sisi Barat)	473.00	unit		473.00		TA 2018
24	Kansteen teraso solid (Pangurakan Sisi Barat)	187.00	unit		187.00		TA 2018
25	Kansteen teraso solid (Pangurakan Sisi Timur)	203.00	unit		203.00		TA 2018
26	Kansteen teraso solid (Margautama)	1,507.00	unit		1,504.00	3.00	TA 2018
Total Kansteen Teraso Solid		3,900.00	unit		3,897.00	3.00	
27	Kansteen pendek teraso (Malioboro Sisi Barat)	42.00	unit		42.00		TA 2018

28	Kansteen pendek teraso (Pangurakan Sisi Barat)	148.00	unit		148.00		TA 2018
29	Kansteen pendek teraso (Pangurakan Sisi Barat)	125.00	unit		125.00		TA 2018
30	Kansteen pendek teraso (Margautama)	1,389.00	unit		1,383.00	6.00	TA 2018
Total Kansteen Pendek Teraso		1,704.00	unit		1,698.00	6.00	
31	Kerb teraso solid (Malioboro Sisi Barat)	740.00	unit		740.00		TA 2018
32	Kerb teraso solid (Margamulya Sisi Barat)	18.00	unit		18.00		TA 2018
33	Kerb teraso solid (Pangurakan Sisi Barat)	12.00	unit		12.00		TA 2018

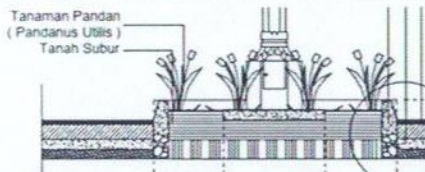
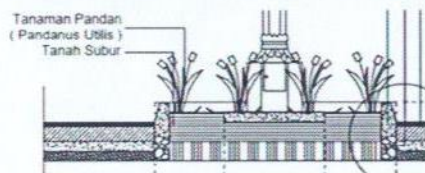

34	Kerb teraso solid (Pangurakan Sisi Timur)	36.00	unit		36.00	TA 2018
35	Kerb setengah lingkaran ujung gmedian (Margautama)	98.00	unit		98.00	TA 2018
Total Kerb		904.00	unit		904.00	
36	Hand railing pembatas PKL (Malioboro Sisi Barat)	114.00	unit		114.00	TA 2018
37	Hand railing pembatas PKL (Margamulya Sisi Barat)	69.00	unit		69.00	TA 2018
Total Hand Railing		183.00	unit		183.00	
38	Pohon Gayam (Malioboro Sisi Barat)	1.00	btg		1.00	TA 2018

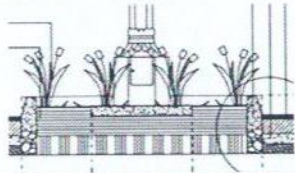
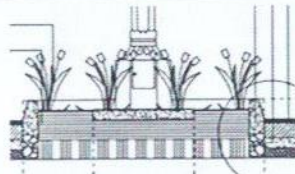
39	Pohon Gayam (Margautama)	6.00	btg		Pohon Gayam	5.00	1.00	TA 2018
Total Pohon Gayam		7.00	btg			6.00	1.00	
40	Pohon Asam (Malioboro Sisi Barat)	1.00	btg		Pohon Asam Jawa	1.00		TA 2018
41	Pohon Asam (Margamulya Sisi Barat)	4.00	btg		Pohon Asam Jawa	4.00		TA 2018
42	Pohon Asam (Margautama)	97.00	btg		Pohon Asam Jawa	97.00		TA 2018
Total Pohon Asam		102.00	btg			102.00		
43	Tanaman soka kuning (Malioboro Sisi Barat)	63.12	m2		Soka merah dan orange	60.96	2.16	TA 2018
Total Tanaman Soka Kuning		63.12	m2			60.96	2.16	

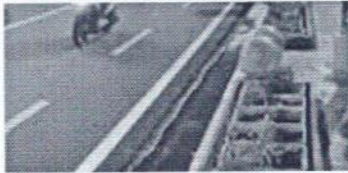
44	Tanaman soka orange (Malioboro Sisi Barat)	72.72	m2	 Soka merah dan orange	69.84	2.88	TA 2018
Total Tanaman Soka Orange		72.72	m2		69.84	2.88	
45	Tanaman soka merah (Malioboro Sisi Barat)	13.20	m2	 Soka merah dan orange	12.48	0.72	TA 2018
46	Tanaman soka merah (Margamulya Sisi Barat)	36.23	m2	 Soka merah dan orange	34.31	1.92	TA 2018
Total Tanaman Soka Merah		49.43	m2		46.79	2.64	
47	Tanaman pandan (Pangurakan Sisi Barat)	23.56	m2		22.36	1.20	TA 2018
48	Tanaman pandan (Pangurakan Sisi Timur)	15.56	m2		14.84	0.72	TA 2018
Total Tanaman Pandan		39.12	m2		37.2	1.92	



49	Tanaman Chupea hyssopifolia (Pangurakan Sisi Timur)	18.72	m2		17.76	0.96	TA 2018
Total Chupea		18.72	m2		17.76	0.96	
50	Tanaman Gardenia Gardenia Augusta (Margautama)	275.65	m2		264.55	11.10	TA 2018
Total Gardenia		275.65	m2		264.55	11.10	
51	Pohon Beringin (Pangurakan Sisi Timur)	6.00	btg		6.00		TA 2018
Total Beringin		6.00	btg		6.00		
52	Pot Plastik (Malioboro Sisi Barat)	621.00	bh		621.00		TA 2018
53	Pot Plastik (Margamulya Sisi Barat)	163.00	bh		163.00		TA 2018

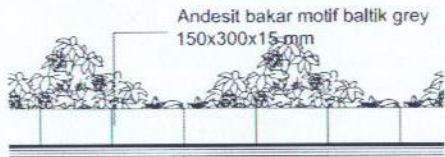
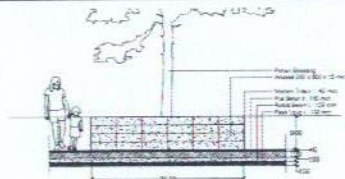

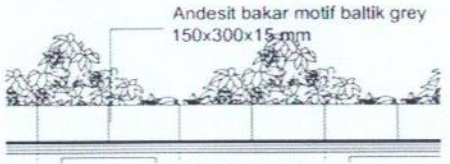
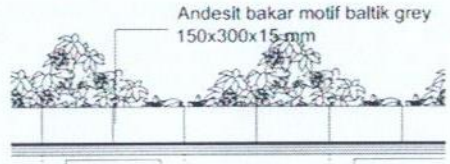
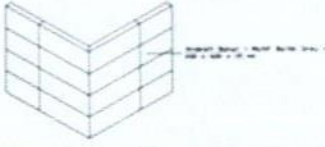
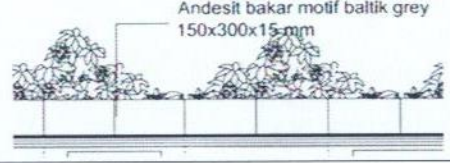
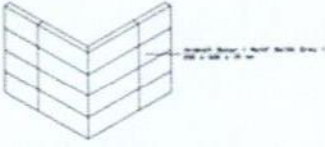
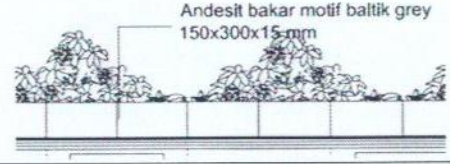
54	Pot Plastik (Pangurakan Sisi Barat)	106.00	bh		106.00		TA 2018
55	Pot Plastik (Pangurakan Sisi Timur)	70.00	bh		70.00		TA 2018
56	Pot Plastik (Margautama)	1,240.00	bh		1,166.00	74.00	TA 2018
Total Pot Plastik		2,200.00	bh		2.126.00	74.00	
57	Pot Gantung (Malioboro Sisi Barat)	33.00	set		33.00		TA 2018
58	Pot Gantung (Margamulya Sisi Barat)	7.00	set		7.00		TA 2018
59	Pot Gantung (Pangurakan Sisi Barat)	12.00	set		12.00		TA 2018

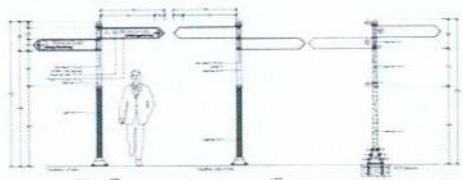
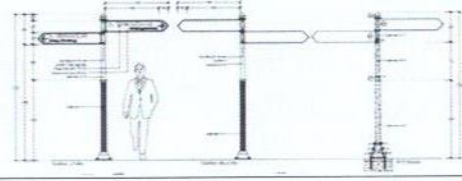
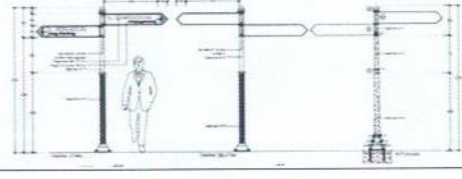
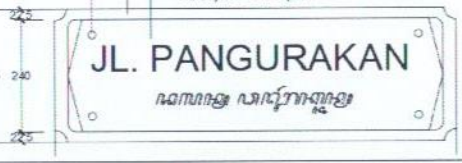
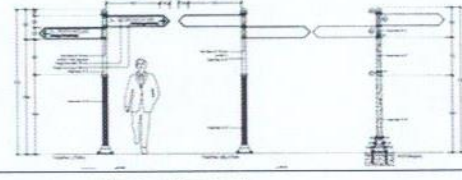
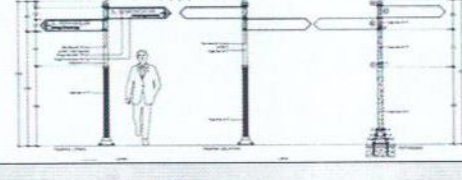

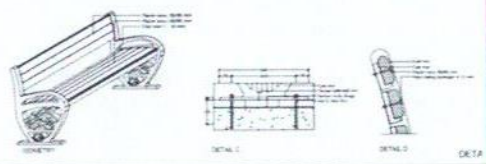
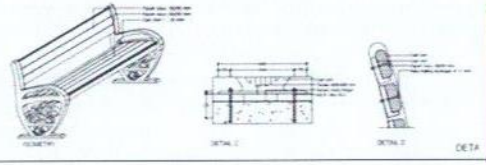
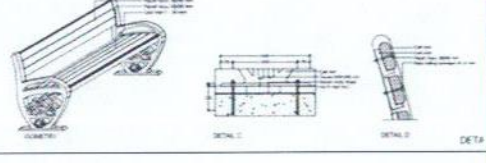
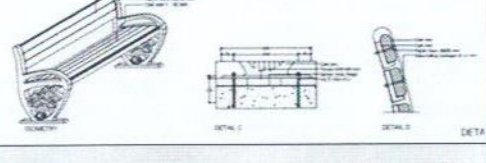
60	Pot Gantung (Pangurakan Sisi Timur)	13.00	set		13.00		TA 2018
61	Pot Gantung (Margautama)	52.00	set		52.00		TA 2018
Total Pot Gantung		117.00	set		117.00		
62	Pot Portable Kantor Pos (Pangurakan Sisi Tmur)	26.00	set		26.00		TA 2018
Total Pot Portable Kantor Pos		26.00	set		26.00		
63	Batu andesit cover pot (Malioboro Sisi Barat)	247.90	m2		246.68	1.22	TA 2018
64	Batu andesit pohon eksisting (Malioboro Sisi Barat)	10.32	m2		10.20	0.12	TA 2018

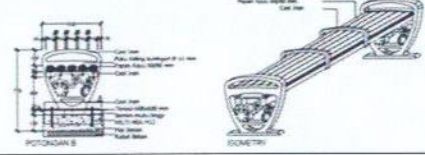

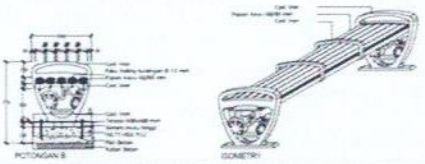
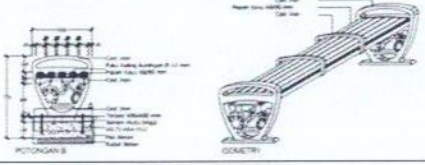
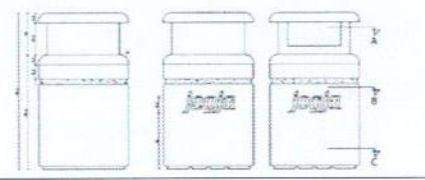
65	Batu andesit cover pot (Margamulya Sisi Barat)	59.43	m2		58.80	0.63	TA 2018
66	Batu andesit cover pot (Pangurakan Sisi Barat)	39.56	m2		39.42	0.14	TA 2018
67	Batu andesit dinding Museum Sonobudoyo (Pangurakan Sisi Barat)	14.02	m2		14.02		TA 2018
68	Batu andesit cover pot (Pangurakan Sisi Timur)	29.64	m2		29.64		TA 2018
69	Batu andesit dinding Telkom (Pangurakan Sisi Timur)	4.95	m2		4.95		TA 2018
70	Batu andesit cover pot (Margautama)	409.50	m2		408.42	1.08	TA 2018
Total Batu Andesit		815.31	m2		812.13	3.19	

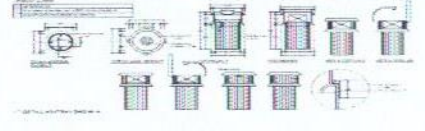

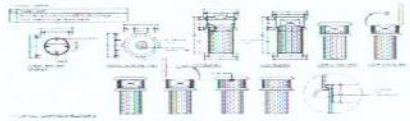
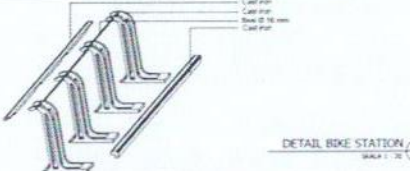
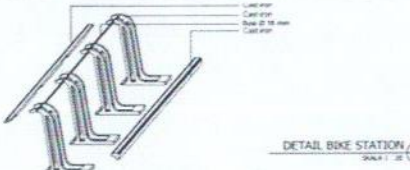
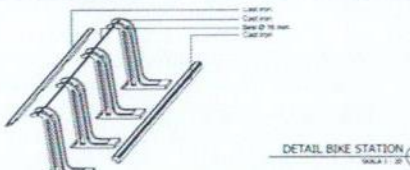
71	Signage Jalan (Malioboro Sisi Barat)	2.00	unit		2.00	TA 2018
72	Signage Jalan (Margamulya Sisi Barat)	1.00	unit		1.00	TA 2018
73	Signage Jalan (Pangurakan Sisi Barat)	1.00	unit		1.00	TA 2018
74	Letter Sonobudoyo (Pangurakan Sisi Barat)	1.00	unit		1.00	TA 2018
75	Signage Jalan (Pangurakan Sisi Timur)	2.00	unit		2.00	TA 2018
76	Signage Jalan (Margautama)	2.00	unit		2.00	TA 2018
Total Signage		9.00	unit		9.00	





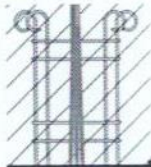
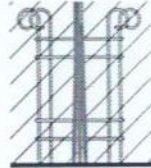
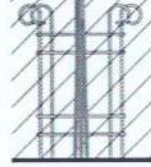

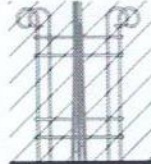
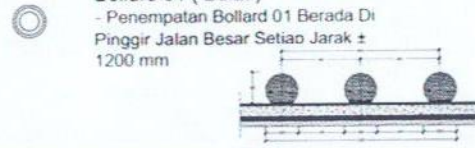
77	Bench Sandaran (Malioboro Sisi Barat)	54.00	unit		54.00		TA 2018
78	Bench Sandaran (Margamulya Sisi Barat)	2.00	unit		2.00		TA 2018
79	Bench Sandaran (Pangurakan Sisi Barat)	19.00	unit		19.00		TA 2018
80	Bench Sandaran (Pangurakan Sisi Timur)	17.00	unit		17.00		TA 2018
Total Bench Sandaran		92.00	unit		92.00		
81	Bench Tanpa Sandaran (Malioboro Sisi Barat)	187.00	unit		185.00	2.00	TA 2018
82	Bench Tanpa Sandaran (Margamulya Sisi Barat)	30.00	unit		28.00	2.00	TA 2018

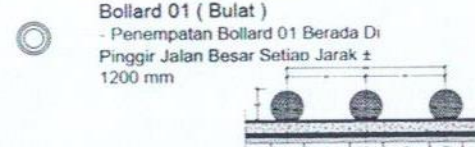
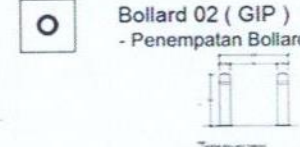
83	Bench Tanpa Sandaran (Pangurakan Sisi Barat)	16.00	unit		14.00	2.00	TA 2018
84	Bench Tanpa Sandaran (Pangurakan Sisi Timur)	14.00	unit		12.00	2.00	TA 2018
Total Bench Tanpa Sandaran		247.00	unit		239	8.00	
85	Trashcan (Malioboro Sisi Barat)	14.00	unit		14.00		TA 2018
86	Trashcan (Pangurakan Sisi Barat)	14.00	unit		14.00		TA 2018
87	Trashcan (Pangurakan Sisi Timur)	12.00	unit		12.00		TA 2018
Total Trashcan		40.00	unit		40.00		
88	Ashtray (Malioboro Sisi Barat)	17.00	unit		17.00		TA 2018

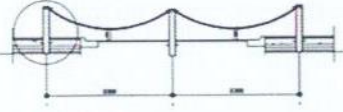

89	Ashtray (Margamulya Sisi Barat)	5.00	unit		4.00	1.00	TA 2018
Total Ashtray		22.00	unit		21.00	1.00	
90	Bike Station (Malioboro Sisi Barat)	4.00	unit		4.00		TA 2018
91	Bike Station (Pangurakan Sisi Barat)	2.00	unit		2.00		TA 2018
92	Bike Station (Pangurakan Sisi Timur)	3.00	unit		3.00		TA 2018
Total Bika Station		9.00	unit		9.00		
93	Trees Grate (Malioboro Sisi Barat)	2.00	unit	 Trees Grate Dan Trees Case - Penempatan Trees Grate Dan Trees Case Berada Di Pohon Baru yang Berjarak ± 9000 mm	2.00		TA 2018

94	Trees Grate (Margamulya Sisi Barat)	4.00	unit		Trees Grate Dan Trees Case - Penempatan Trees Grate Dan Trees Case Berada Di Pohon Baru yang Berjarak ± 9000 mm	4.00		TA 2018
95	Trees Grate (Pangurakan Sisi Timur)	6.00	unit		Trees Grate Dan Trees Case - Penempatan Trees Grate Dan Trees Case Berada Di Pohon Baru yang Berjarak ± 9000 mm	6.00		TA 2018
96	Trees Grate (Margautama)	103.00	unit		Trees Grate Dan Trees Case - Penempatan Trees Grate Dan Trees Case Berada Di Pohon Baru yang Berjarak ± 9000 mm	102.00	1.00	TA 2018
Total Trees Grate		115.00	unit			114.00	1.00	
97	Trees Case (Malioboro Sisi Barat)	2.00	unit		Trees Grate Dan Trees Case - Penempatan Trees Grate Dan Trees Case Berada Di Pohon Baru yang Berjarak ± 9000 mm	2.00		TA 2018
98	Trees Case (Margamulya Sisi Barat)	4.00	unit		Trees Grate Dan Trees Case - Penempatan Trees Grate Dan Trees Case Berada Di Pohon Baru yang Berjarak ± 9000 mm	4.00		TA 2018
99	Trees Case (Pangurakan Sisi Ti,mur)	6.00	unit		Trees Grate Dan Trees Case - Penempatan Trees Grate Dan Trees Case Berada Di Pohon Baru yang Berjarak ± 9000 mm	6.00		TA 2018

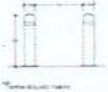
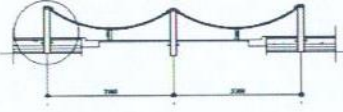
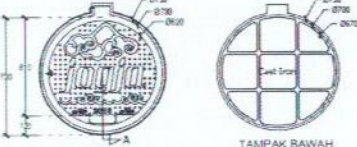
100	Trees Case (Margautama)	103.00	unit	 <p>Trees Grate Dan Trees Case - Penempatan Trees Grate Dan Trees Case Berada Di Pohon Baru yang Berjarak ± 9000 mm</p>	101.00	2.00	TA 2018
Total Trees Case		115.00	unit		113.00	2.00	
101	Bollard Bulat (Malioboro Sisi Barat)	367.00	bh	 <p>Bollard 01 (Bulat) - Penempatan Bollard 01 Berada Di Pinggir Jalan Besar Setiap Jarak ± 1200 mm</p>	355.00	12.00	TA 2018
102	Bollard Bulat (Margamulya Sisi Barat)	128.00	bh	 <p>Bollard 01 (Bulat) - Penempatan Bollard 01 Berada Di Pinggir Jalan Besar Setiap Jarak ± 1200 mm</p>	128.00		TA 2018
103	Bollard Bulat (Pangurakan Sisi Timur)	110.00	bh	 <p>Bollard 01 (Bulat) - Penempatan Bollard 01 Berada Di Pinggir Jalan Besar Setiap Jarak ± 1200 mm</p>	110.00		TA 2018
Total Bollard Bulat		605.00	bh		593.00	12.00	
104	Bollard Tabung (Malioboro Sisi Barat)	32.00	bh	 <p>Bollard 02 (GIP) - Penempatan Bollard 02 Jarak ± 600 mm</p>	32.00		TA 2018

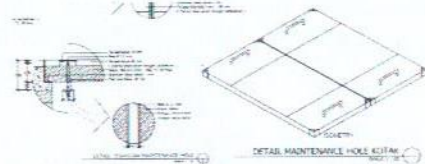
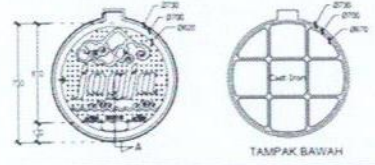
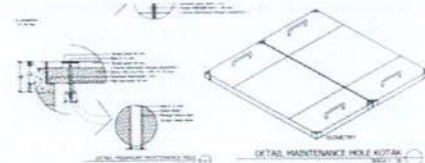
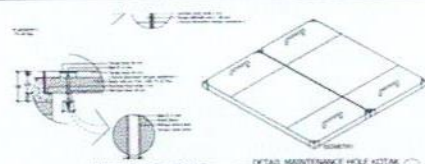
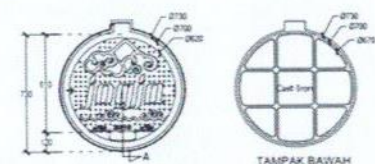
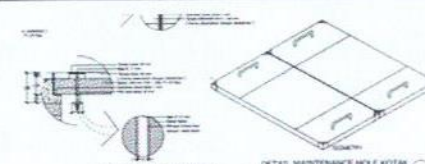
105	Bollard Tabung (Margamulya Sisi Barat)	34.00	bh	 <p>Bollard 02 (GIP) - Penempatan Bollard 02 Jarak ± 600 mm</p> 	34.00	TA 2018
106	Bollard Tabung (Pangurakan Sisi Barat)	69.00	bh	 <p>Bollard 02 (GIP) - Penempatan Bollard 02 Jarak ± 600 mm</p> 	69.00	TA 2018
107	Bollard Tabung Rantai+gembok (Pangurakan Sisi Barat)	6.00	bh	 <p>MOTONGAN DETAIL BOLLARD GAGUNG SKALA 1 : 25</p>	6.00	TA 2018
108	Bollard Tabung (Pangurakan Sisi Timur)	135.00	bh	 <p>Bollard 02 (GIP) - Penempatan Bollard 02 Jarak ± 600 mm</p> 	135.00	TA 2018
109	Bollard Tabung Rantai+gembok (Pangurakan Sisi Timur)	12.00	bh	 <p>MOTONGAN DETAIL BOLLARD GAGUNG SKALA 1 : 25</p>	12.00	TA 2018
Total Bollard Tabung		288.00	bh		288.00	
110	Maintenance Hole Logo Jogja (Malioboro Sisi Barat)	10.00	unit		10.00	TA 2018

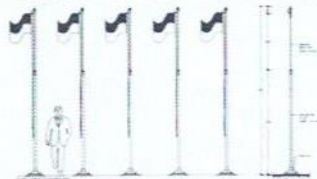
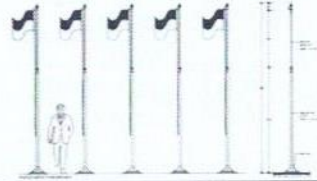
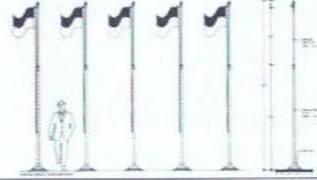
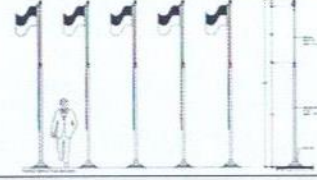
111	Maintanance Hole Kotak (Malioboro Sisi Barat)	7.00	unit		7.00	TA 2018
112	Maintanance Hole Logo Jogja (Margamulya Sisi Barat)	2.00	unit		2.00	TA 2018
113	Maintanance Hole Kotak (Margamulya Sisi Barat)	2.00	unit		2.00	TA 2018
114	Maintanance Hole Kotak (Pangurakan Sisi Barat)	8.00	unit		8.00	TA 2018
115	Maintanance Hole Logo Jogja (Pangurakan Sisi Timur)	2.00	unit		2.00	TA 2018
116	Maintanance Hole Kotak (Pangurakan Sisi Timur)	11.00	unit		11.00	TA 2018
Total Maintenance Hole		42.00	unit		42.00	

117	Tiang Bendera (Malioboro Sisi Barat)	20.00	unit		20.00		TA 2018
118	Tiang Bendera (Margamulya Sisi Barat)	10.00	unit		10.00		TA 2018
119	Tiang Bendera (Pangurakan Sisi Barat)	5.00	unit		5.00		TA 2018
120	Tiang Bendera (Pangurakan Sisi Timur)	10.00	unit		9.00	1.00	TA 2018
Total Tiang Bendera		45.00	unit		44.00	1.00	
121	Drinking Fountain (Malioboro Sisi Barat)	2.00	unit		1.00	1.00	TA 2018
Total Drinking Fountain		2.00	unit		1.00	1.00	

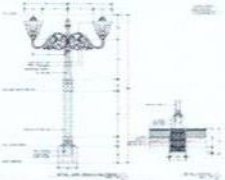
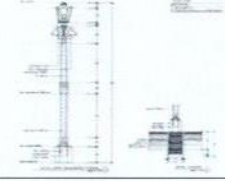
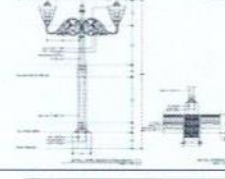
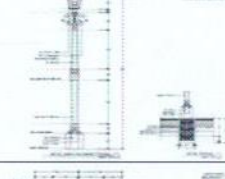
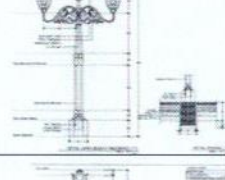
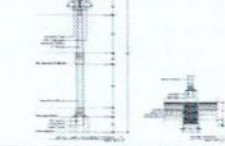
122	Lampu Budaya 3 1x50 W (Malioboro Sisi Barat)	12.00	bh		11.00	1.00	TA 2018
123	Lampu Budaya Tunggal (Malioboro Sisi Barat)	9.00	bh		9.00		TA 2018
124	Rekondisi Lampu Budaya (Malioboro Sisi Barat)	12.00	bh		12.00		TA 2018
125	Lampu Budaya 3 1x50 W (Margamulya Sisi Barat)	3.00	bh		3.00		TA 2018
126	Rekondisi Lampu Budaya (Margamulya Sisi Barat)	4.00	bh		4.00		TA 2018
127	Lampu Budaya 3 1x50 W (Pangurakan Sisi Barat)	7.00	bh		7.00		TA 2018

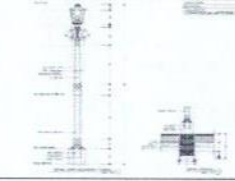
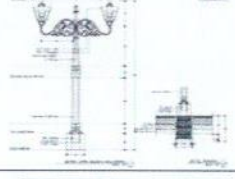
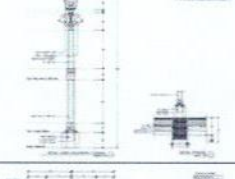
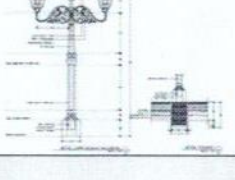
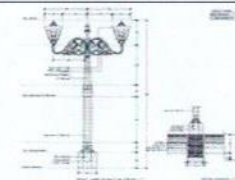
128	Rekondisi Lampu Budaya (Pangurakan Sisi Barat)	5.00	bh		5.00		TA 2018
129	Lampu Budaya 3 1x50 W (Pangurakan Sisi Timur)	7.00	bh		7.00		TA 2018
130	Rekondisi Lampu Budaya (Pangurakan Sisi Timur)	6.00	bh		6.00		TA 2018
131	Lampu Budaya 3 1x50 W (Margautama)	22.00	bh		22.00		TA 2018
132	Rekondisi Lampu Budaya (Margautama)	30.00	bh		30.00		TA 2018
Total Lampu Budaya		117.00	bh		116.00	1.00	
133	Rekondisi Lampu Arcade (Malioboro Sisi Barat)	68.00	unit		68.00		TA 2018

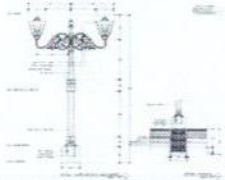
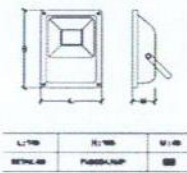
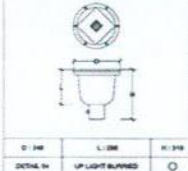
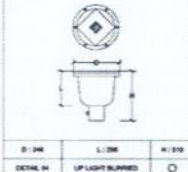
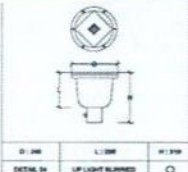
134	Rekondisi Lampu Arcade (Margamulya Sisi Barat)	6.00	unit		6.00	TA 2018
Total Lampu Arcade		74.00	unit		74.00	
135	Lampu Burried (Malioboro Sisi Barat)	10.00	bh		10.00	TA 2018
Total Burried		10.00	bh		10.00	
136	Lampu Flood Light LED 20 W (Malioboro Sisi Barat)	118.00	bh		118.00	TA 2018
137	Lampu Flood Light LED 20 W (Margamulya Sisi Barat)	34.00	bh		34.00	TA 2018
138	Lampu Flood Light LED 20 W (Pangurakan Sisi Timur)	12.00	bh		12.00	TA 2018

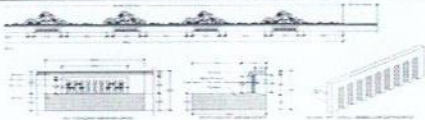
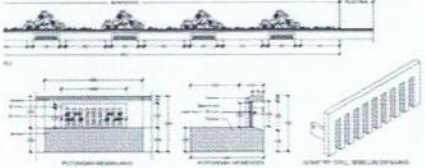
139	Lampu Flood Light LED 20 W (Margautama)	206.00	bh		181.00	25.00	TA 2018
Total Lampu Flood Light		370.00	bh		345.00	25.00	
140	Cast Iron Grill (Malioboro Sisi Barat)	409.00	unit		407.00	2.00	TA 2018
141	Cast Iron Grill (Margamulya Sisi Barat)	78.00	unit		78.00		TA 2018
142	Cast Iron Grill (Pangurakan Sisi Barat)	38.00	unit		38.00		TA 2018
143	Cast Iron Grill (Pangurakan Sisi Timur)	49.00	unit		49.00		TA 2018
144	Cast Iron Grill (Margautama)	162.00	unit		156.00		TA 2018
Total Cast Iron		736.00	unit		734.00	2.00	

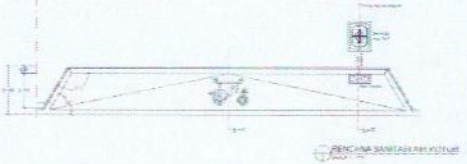
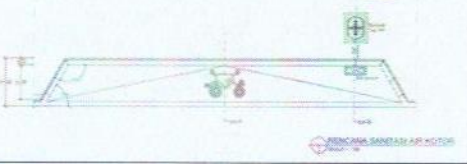
145	Instalasi Limbah Andong (Malioboro Sisi Barat)	10.00	unit		10.00	TA 2018
146	Instalasi Limbah Andong (Margamulya Sisi Barat)	2.00	unit		2.00	TA 2018
Total Instalasi Limbah Andong		12.00	unit		12.00	

GUBERNUR
 DAERAH ISTIMEWA YOGYAKARTA,

 HAMENGGU BUWONO X